

A-SERIES WINCH MOTOR

INSTALLATION

Winch Motor PART # Motor-30-BL

Kit Components:

Qty. Part Description

1..... Motor

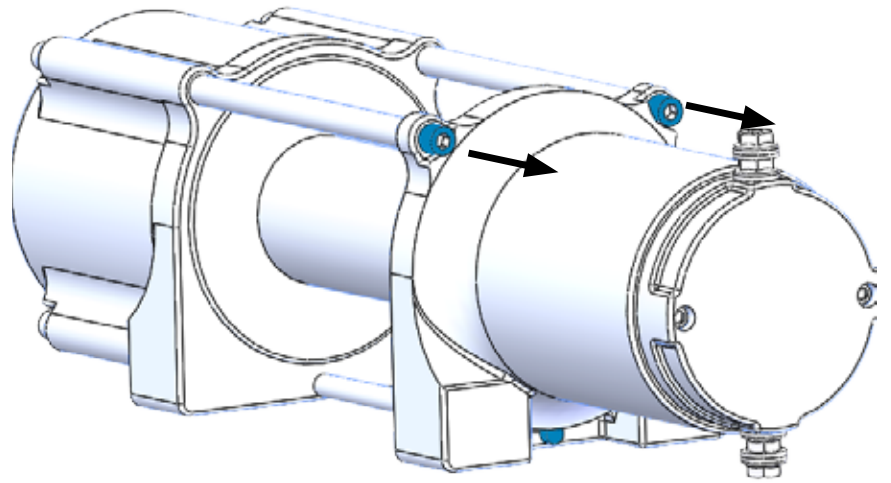

INSTALLATION INSTRUCTIONS:

“Figure 1”

1. Remove the two bolts that attach the motor, as shown in Figure 1.
2. Remove Coupler (A) from the old motor, as shown in Figure 2.
3. Insert the coupler onto the shaft of the new motor.
4. Set the new motor on the winch and reattach using the bolts removed in step 1.
5. Tighten all hardware evenly.

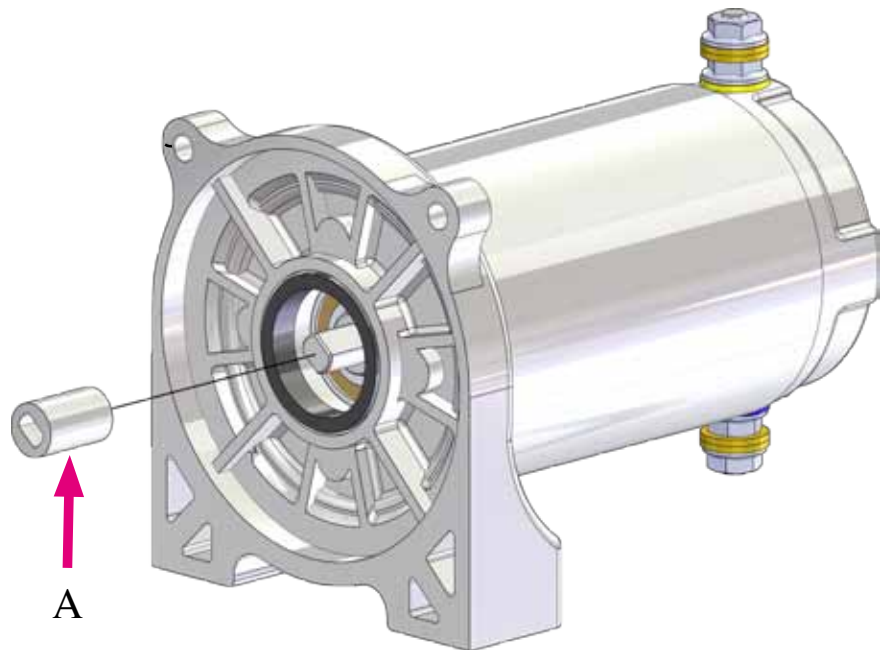

“Figure 2”